

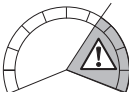

1



# Kit 187119



FORD Transit, 4-dr Van, 15-



  **Max 130 km/h  
80 Mph**

 +  **7 kg  
15,4 lbs** = **Max: 100 kg  
/ 220 lbs**

  **80 km/h  
50 Mph** 

 +  **14 kg  
30,8 lbs** = **Max: 150 kg  
/ 330 lbs**

ISO 11154-E





This kit is only for vehicles with fixpoint mounting.

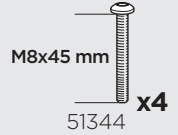
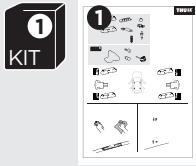

**i**

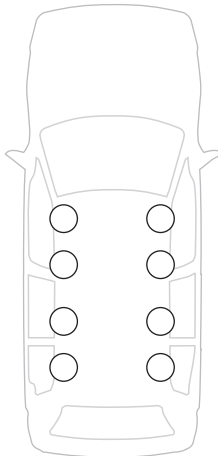
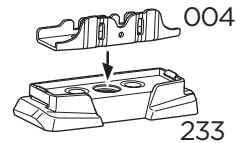
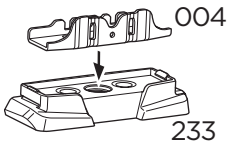
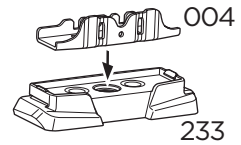
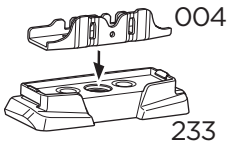

1  
A

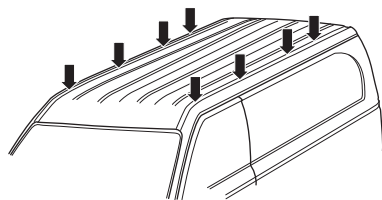

B

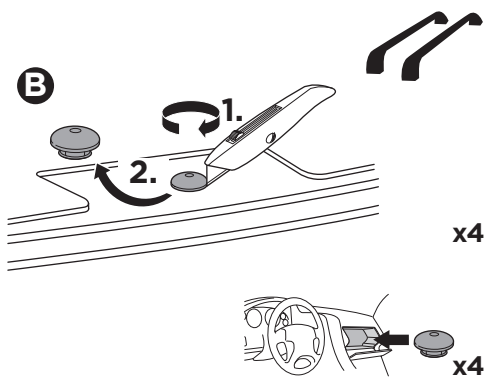

2

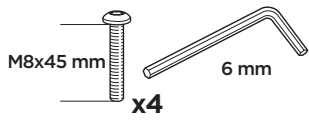

8 Nm

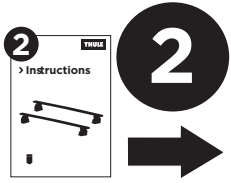
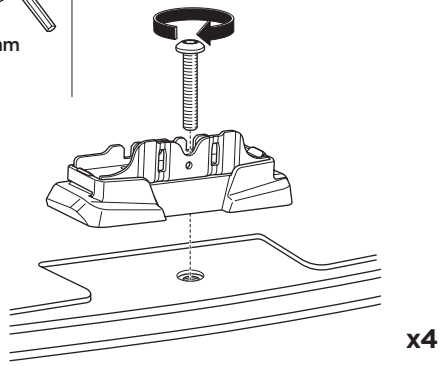



This kit is only for vehicles with fixpoint mounting.

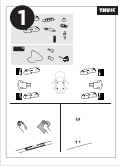

x2

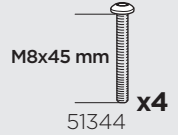

**i**

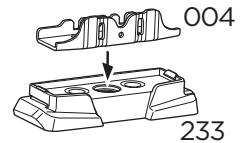
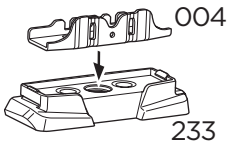
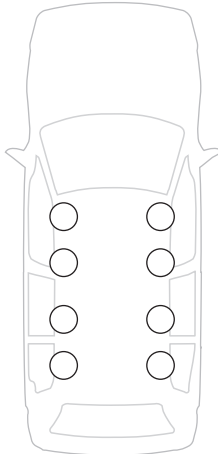
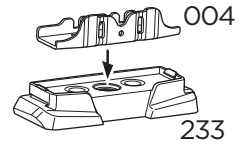
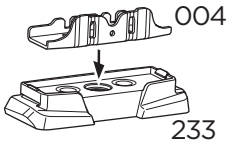

1 A

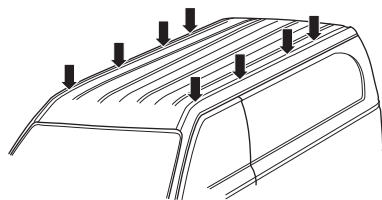

B

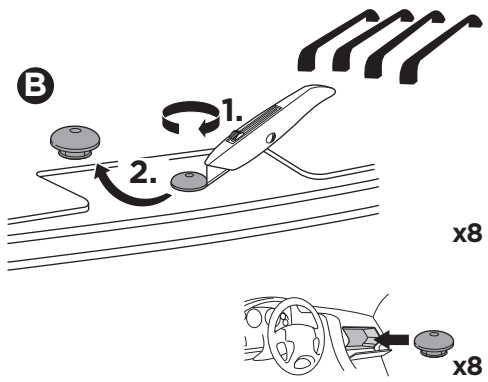

2

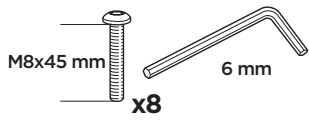

8 Nm

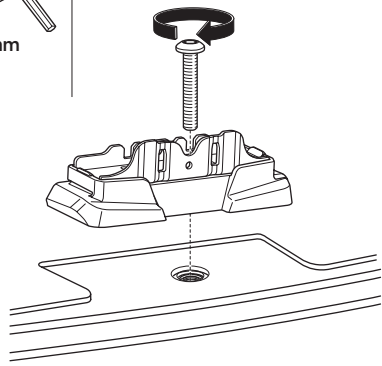

**i**



**A**

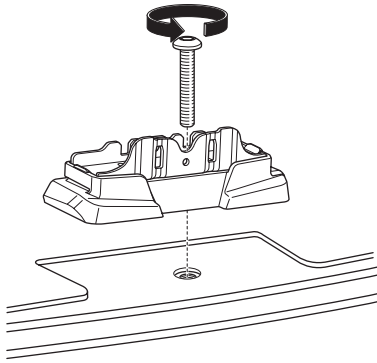

**B**

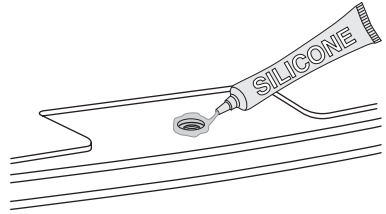

**C**

