

ciao

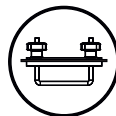

All the pleasure of travelling

Montageanleitung | Installation instruction

Istruzioni di montaggio | Instructions de montage | Montage-instructies | Instrucciones de montaje | Instruções de montagem | Monteringsanvisning
Asennusohje | Paigaldusjuhend | Stiprinašanas instrukcija | Pritvirtinimo instrukcijos | Instrukcja montażu | Navod na montaz | Montaj talimatları

A

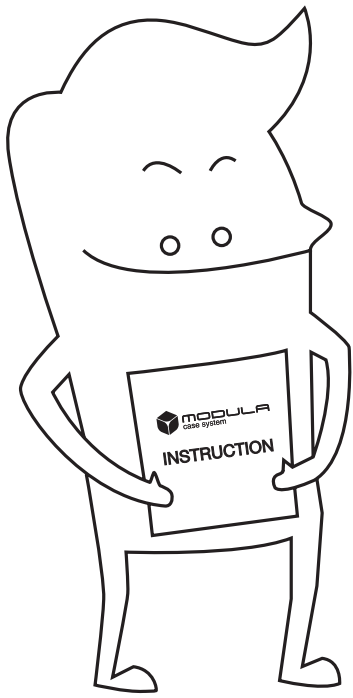

B

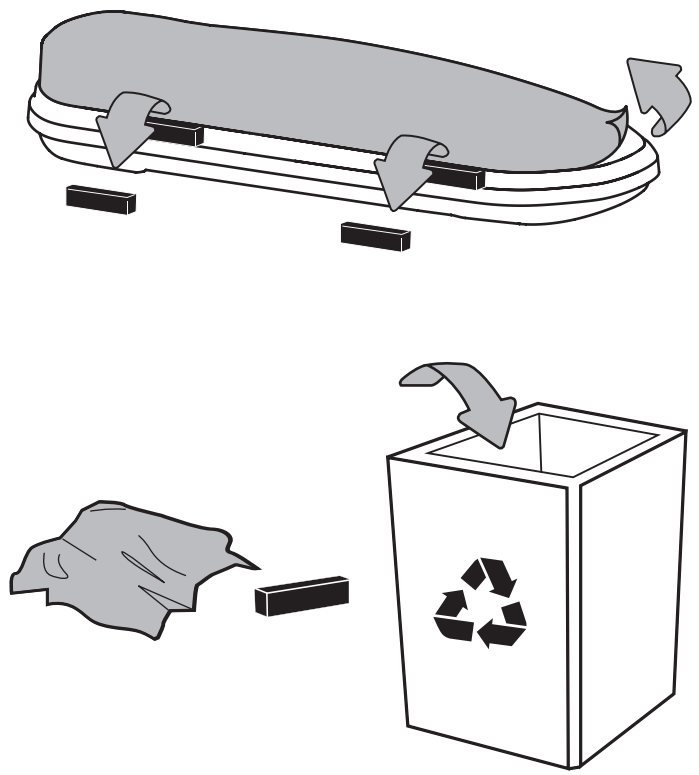

C

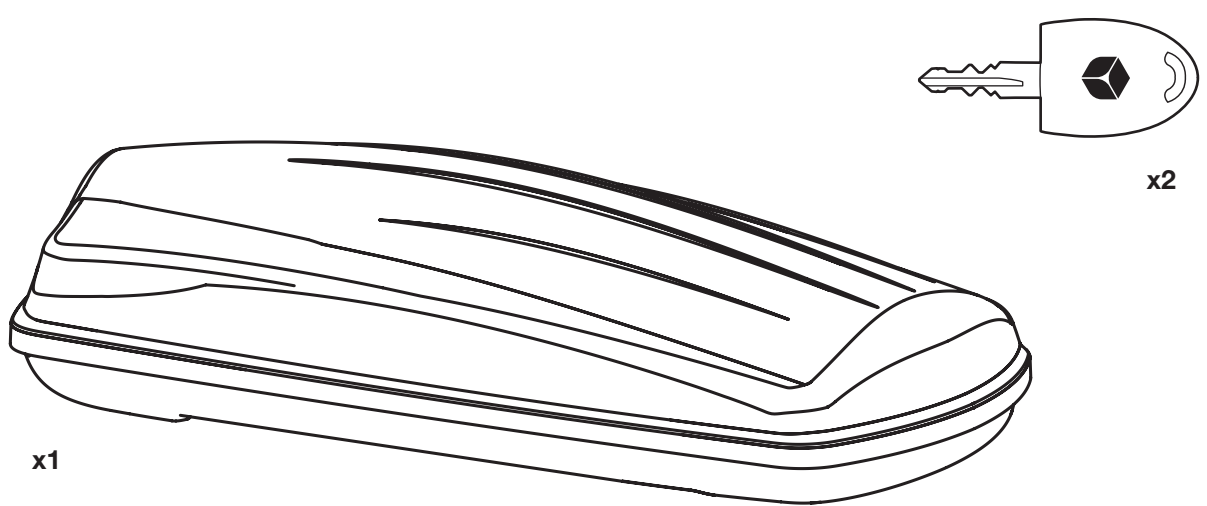

1

310 28 MIN | 79 cm MAX
340 19 MIN | 78 cm MAX
430 41 MIN | 98 cm MAX
580 60 MIN | 125 cm MAX

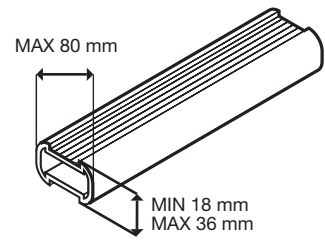
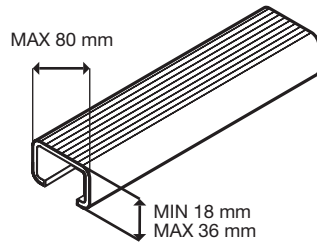
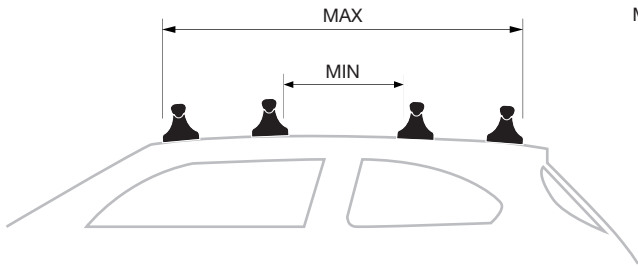

2

2.1

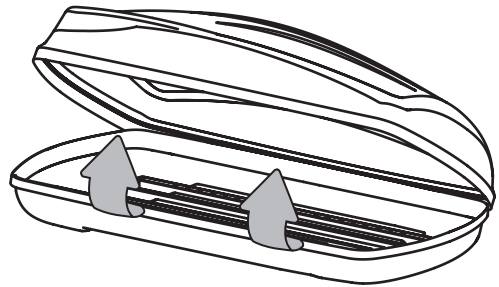
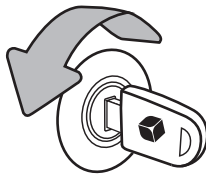
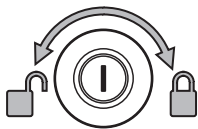

2.2

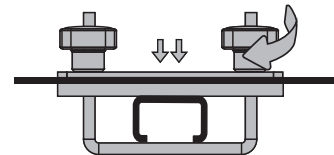
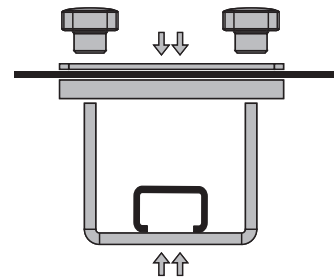
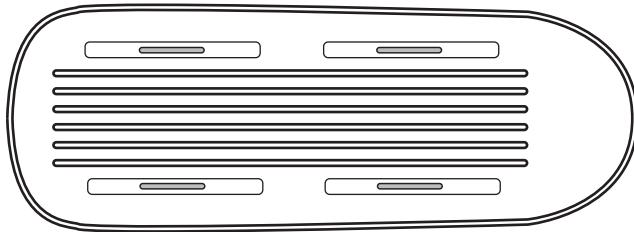

2.3

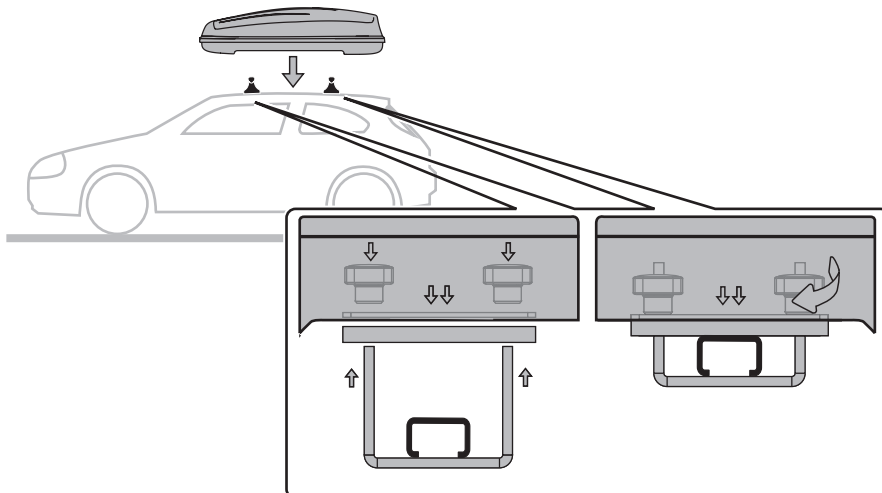

YES

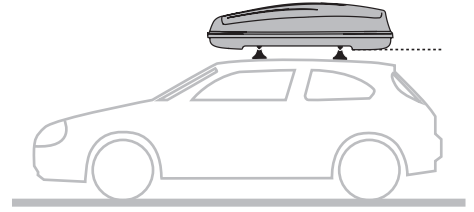
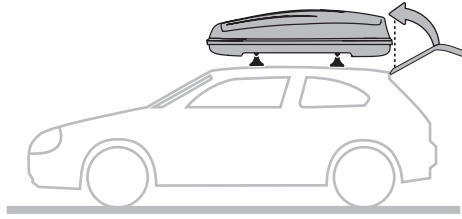
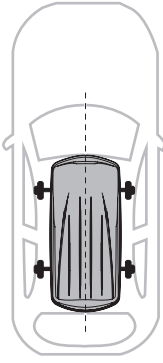

NO

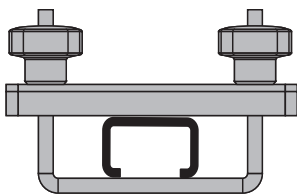
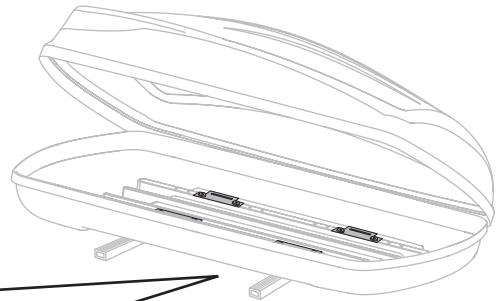
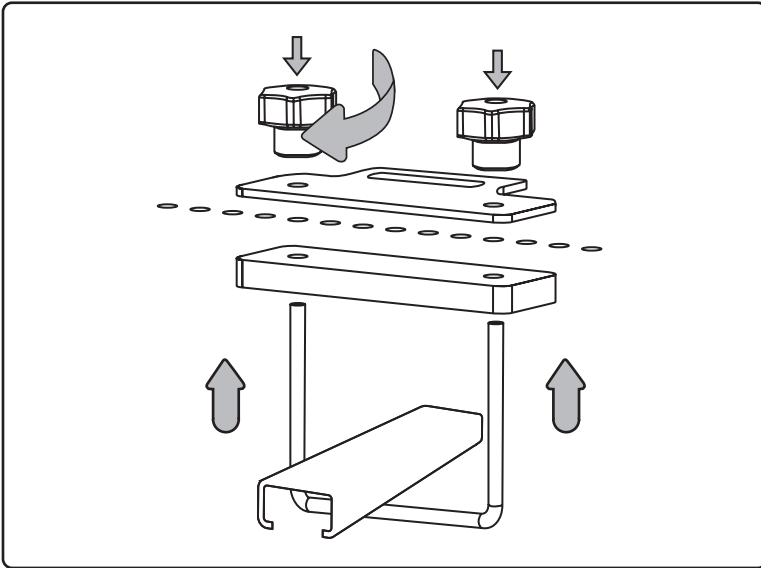
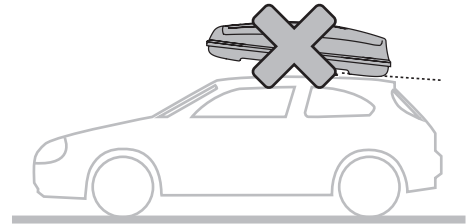
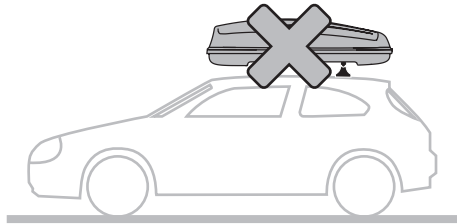
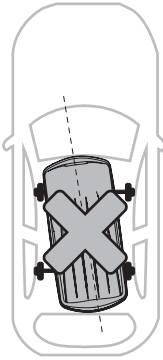

YES

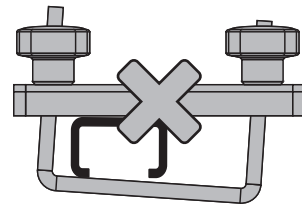

NO

4.1

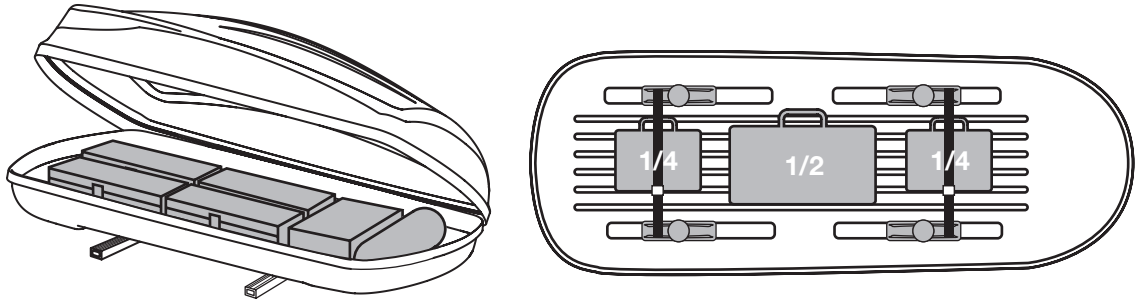

4.2

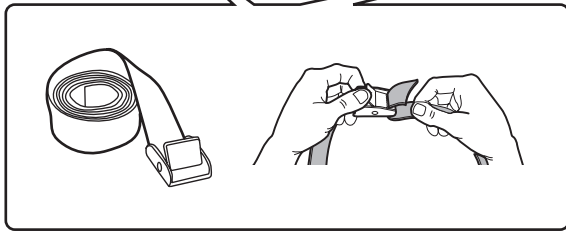
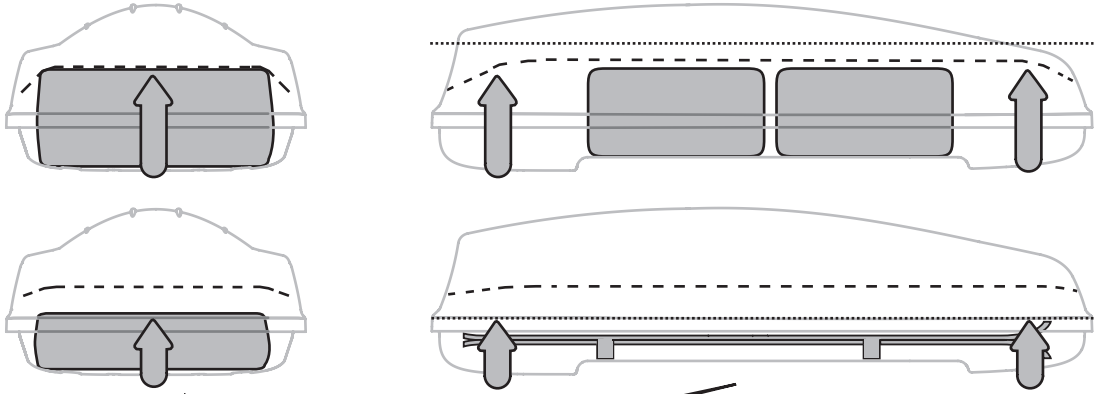

NO

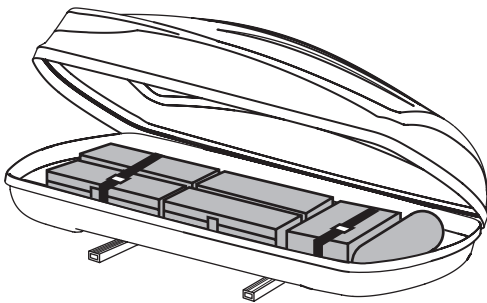
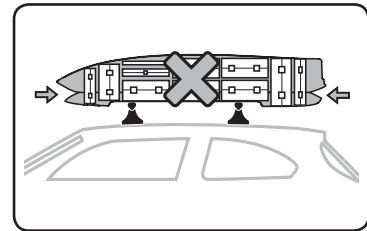

YES

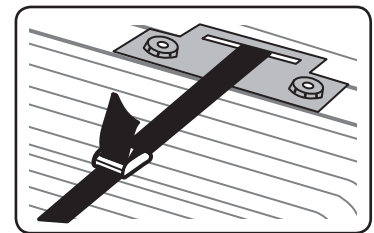

YES

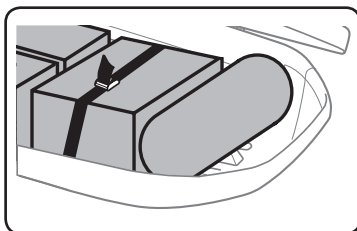

NO

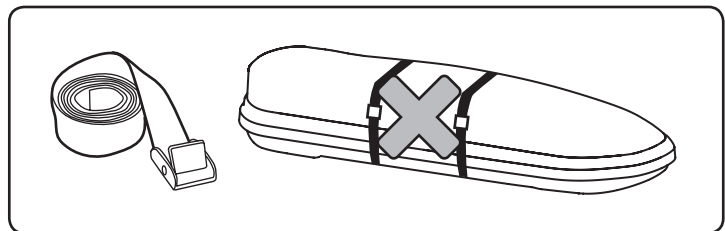

6

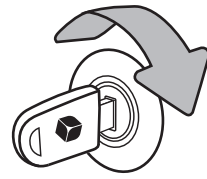
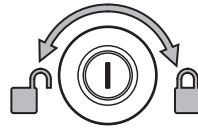
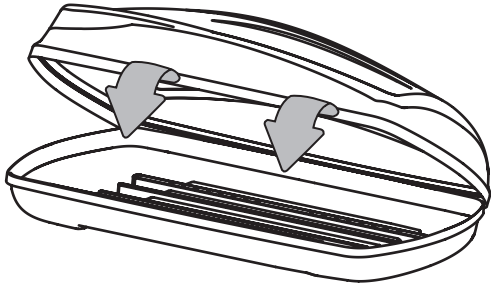

7

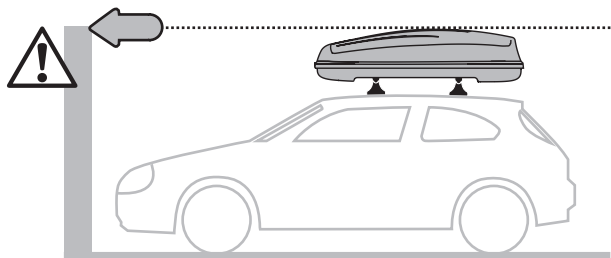
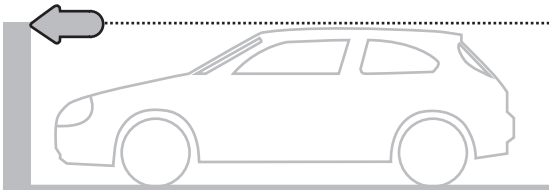

8

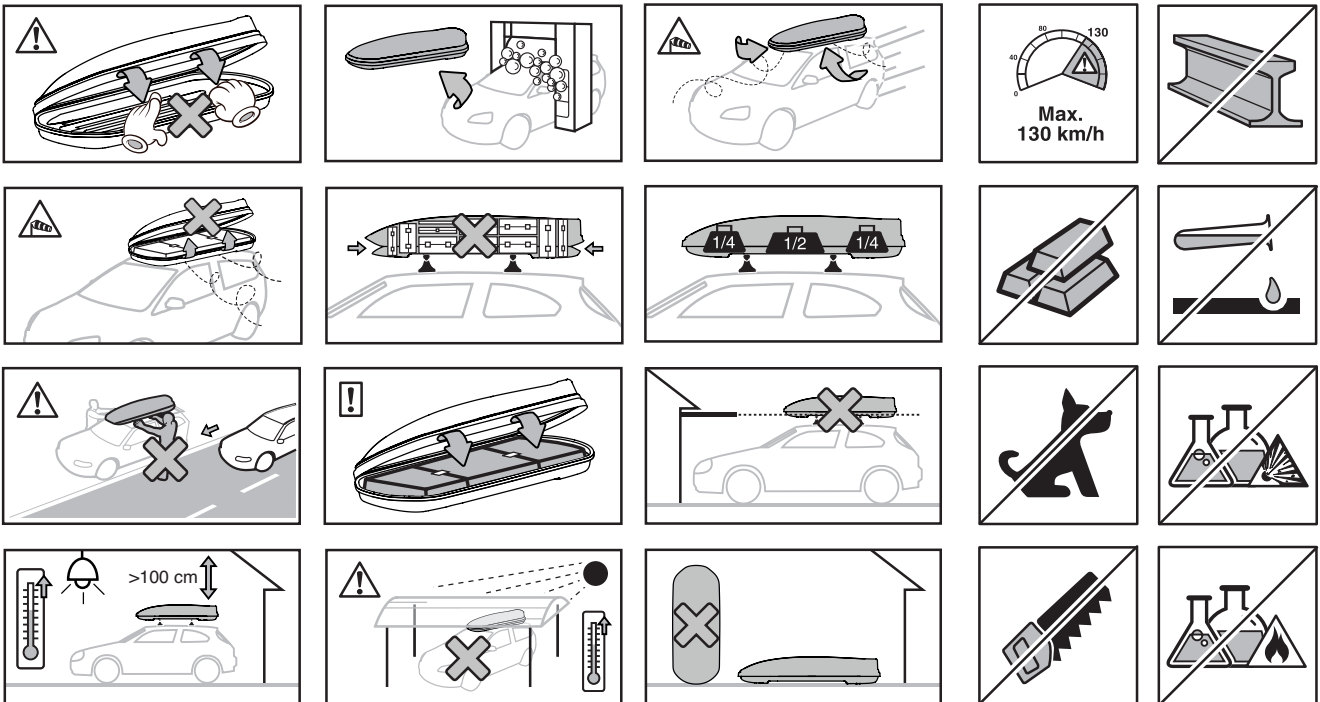

CIAO 310

Größe/Dimensions **L 126 W 78 H 35 cm** | Volumen/Volume **310 liter** | Zuladung/Capacity **75 kg** | Gewicht/Weight **7,4 kg**

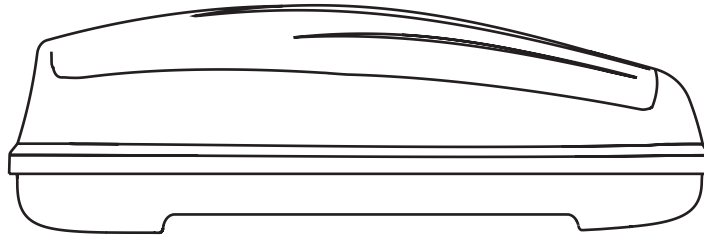

CIAO 340

Größe/Dimensions **L 140 W 80 H 44 cm** | Volumen/Volume **340 liter** | Zuladung/Capacity **75 kg** | Gewicht/Weight **11 kg**

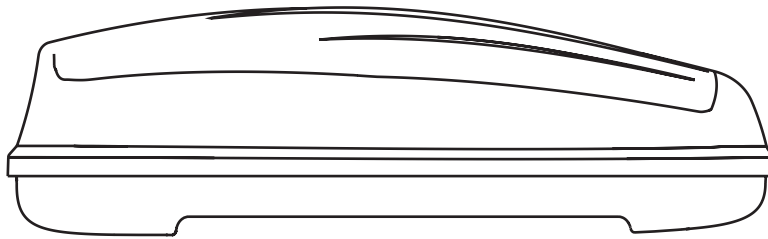

CIAO 430

Größe/Dimensions **L 175 W 80 H 44 cm** | Volumen/Volume **430 liter** | Zuladung/Capacity **75 kg** | Gewicht/Weight **12,4 kg**

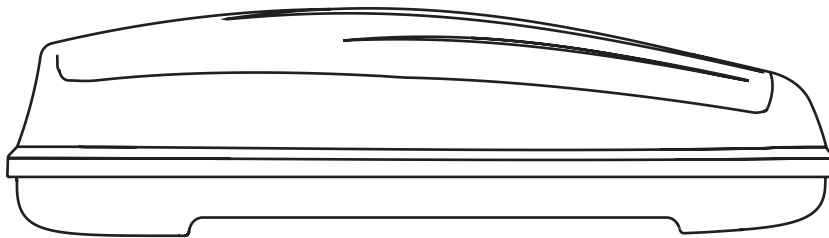

CIAO 580

Größe/Dimensions **L 220 W 92 H 44 cm** | Volumen/Volume **580 liter** | Zuladung/Capacity **75 kg** | Gewicht/Weight **20 kg**

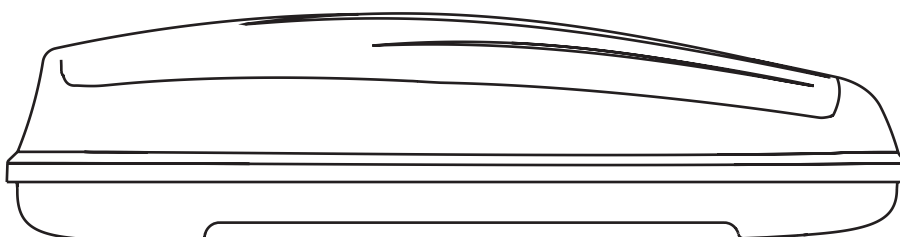

Požiadavky a odporúčania:

Po krátkej jazde v prvých a určitých časových úsekoch, v závislosti od stavu vozovky, je potrebné skontrolovať skrutkové spoje a upevnenie strešného boxu.

Pri montáži strešného boxu, najmä pri naložení, sa menia jazdné vlastnosti vozidla (náchýlné na bočný vietor, nakláňanie v zatáčkách a brzdenie).

Z dôvodu bezpečnosti ostatných účastníkov cestnej premávky az dôvodov úspory energie by sa mal strešný box v čase nepoužívania demontovať zo strechy.

Je potrebné dodržiavať informácie uvedené výrobcom vozidla týkajúce sa prípustného zaťaženia strechy.

Zvážte náklad v boxe, pretože prípustné zaťaženie strechy je kombináciou skutočného zaťaženia, pripočítaním hmotnosti strešných nosičov a kontajnera.

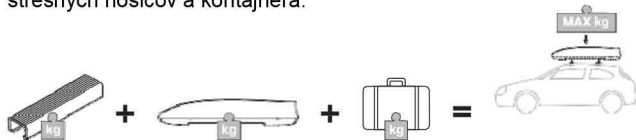

Strešný box musí byť namontovaný v smere jazdy bez vzostupnej línie sklonu, aby sa predišlo zvýšeniu zdvíhacích síl.

POZOR:

Je veľmi dôležité dodržiavať pokyny na montáž a použitie.

Upevnite správne box a pravidelne doťahujte a kontrolujte Dotiahnutie spojovacích prvkov počas cesty.

Tento návod si bezpečne uschovajte.

Batožinu strešného boxu správne a bezpečne zaistíte.

Je dôležité udržiavať zariadenie v dobrom prevádzkovom stave.

Requirements and recommendations:

After a short travel at first and specific time periods, depending on the road conditions, the bolt connections and the roof container fixing have to be checked.

The driving behavior of the vehicle changes (vulnerability to side winds, cornering and breaking behavior) when the roof container is mounted, especially when loaded.

By reasons of safety of other traffic participants and for matters of energy saving, the roof container should be taken off during periods of no use.

The information stated by the vehicle's manufacturer, concerning the permissible roof load, has to be followed.

Consider the weight of the container, since permissible roof load is a combination of the actual load, adding the weight of the roof racks and container.

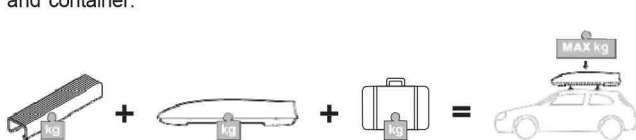

The roof container has to be mounted in direction of the travel without a positive angle of incidence, to avoid any increase in lifting forces.

Warning:

It is very important to follow the instructions of fitting and use;

Tighten and check the fixing devices correctly and regularly during travel;

Keep this instruction manual safely;

Secure the roof container load correctly and safe;

It is important to maintain the equipment in good working order.

Produced and distributed under Sparco's Official Licence
by Modula Case Systems



Brand of Modula srl
Loc. Penisola 20/A
61026 Piandimeleto (PU) Italy
P +39 0722700070
F +39 0722 720017

W www.modulacs.com

E info@modulacs.com

Design and Manufacture Made in Italy

COCS090210

